



PASSION FOR INNOVATION



WINTER 2024/25



PASSION FOR INNOVATION

WINTER 2024/25

NORDIC POLES

PRO RACING	7
RACING	11
ADVANCED	12
AMATEUR	13
KIDS	14

TOURING POLES

SKI TOURING	17
SNOW TOURING	19

ACCESSORIES

HANDLES	23
STRAPS	24
DISKS & TIPS	26
QCD SYSTEM	27
BAGS	28
EQUIPMENT	34
BINDINGS	35
SKIS	36

SHOES

XC SHOES	39
TREKKING SHOES	41

EYEWEAR

45

APPAREL

TECHNICAL	54
JACKETS	68
FREE TIME	74
KIDS	78
UNDERWEAR	81
GLOVES	87
HEADWEAR	93

SHAFTS FEATURES

TORNADO LIGHT

- 100% carbon
- Dynamic graphics
- Stiffer and light carbon
- Proportional stiffness calculation: longer poles are now as stiff as shorter ones
- Diameter at the top 16.5 mm and at the bottom 8.5 mm
- Optimally balanced for light swing

TORNADO PLUS / BORA

- 100% carbon
- Dynamic graphics
- Stiffer carbon
- Proportional stiffness calculation: longer poles are now as stiff as shorter ones
- Diameter at the top 16.5 mm and at the bottom 8.5 mm
- Python Twist Tech: the bottom part is reinforced with additional carbon bands that increase shaft stiffness and provide shock resistance to the pole
- Optimally balanced for light swing

STORM / TORNADO PINK / ELITE

- 100% carbon
- Dynamic graphics
- Stiffer carbon
- Proportional stiffness calculation: longer poles are now as stiff as shorter ones
- Diameter at the top 16.5 mm and at the bottom 8.5 mm
- Optimally balanced for light swing

TORNADO PLUS JUNIOR

- Colour similar to TORNADO PLUS
- 80% carbon
- Diameter at the top 16.5 mm and at the bottom 10 mm
- The adequate balance point allows good pending movement
- Very stable

TORNADO JUNIOR

- Colour similar to TORNADO
- 30% carbon
- Diameter at the top 16.5 mm and at the bottom 10 mm
- Good stability

FUTURE

- Nice colours for kids
- 10% carbon
- Diameter at the top 16.5 mm and at the bottom 10 mm

TEMPESTA

- Available in 2 different colours
- 100% carbon
- Diameter at the top 16.5 mm and at the bottom 10 mm
- The balance point allows good pending movement
- Very stable

VIKING

- White and black colour easy to combine with all ski colours
- 70% carbon
- Diameter at the top 16.5 mm and at the bottom 10 mm
- Very stable

ADVANCE

- 50% carbon
- Diameter at the top 16.5 mm and at the bottom 10 mm
- Good stability

CAMPRA

- Available in 2 different colours
- 30% carbon, from 150 cm 40% carbon
- Diameter at the top 16.5 mm and at the bottom 10 mm
- Good stability

SIMANO

- Nice soft colours
- SIMANO 30% carbon
- Top diameter SIMANO 16.5 mm
- Bottom diameter 10 mm

SHAFTS



PTT Python Twist Tech: the bottom part is reinforced with additional carbon bands that increase shaft stiffness and provide shock resistance to the pole.



Super Light Best carbon compound to give maximum lightness and stiffness.



UNPAINTED: The lower part of the stick is not painted, which makes the stick more solid and greener (reduced use of paint).



STIFFNESS: We measure here the stiffness/flexibility of the stick. The 80cm length of the lower part of the tube is stressed until it is bent by 15mm. The resistance is measured in kg and corresponds to the weight of the thrust. The results were divided into 3 categories, namely:
1 = SUPERIOR (from 17 kg to 21 kg)
2 = GOOD (11 kg to 14 kg)
3 = MEDIUM (7 kg to 10 kg)



SWING: A good balance of the pole leads to a better momentum of the movement. The balance of the stick is measured in cm starting from the centre of gravity of the tube and calculating the difference between the lower and upper parts. The results were divided into 3 categories namely:
1 = SUPERIOR (from 13cm to 16cm)
2 = GOOD (6cm to 10cm)
3 = MEDIUM (2cm to 5cm)



Rubber cover for tip protection during transport.

HANDLES



FAST • Automatic closing system
 • Easy to use
 • Clip System
 • Thermo-cork
 • Top to strap 4.8cm



CARBON • Easy to use
 • Clip system
 • Thermo-cork
 • Longer shape
 • Best strap & handle connect.
 • Lightweight
 • Top-strap distance 4 cm



FALCON • Easy to use
 • Thermo-cork
 • Longer shape
 • Best strap-handle connection
 • Top to strap 4 cm



FALCON C • Easy to use
 • Clip system
 • Thermo-cork
 • Longer shape
 • Best strap-handle connection
 • Top to strap 4 cm



Elite C • Easy to use
 • Clip system
 • Thermo-cork
 • Longer shape
 • Top to strap 4.5 cm



Elite • Easy to use
 • Thermo-cork
 • Longer shape
 • Top-strap distance 4 cm



RACE 3 • Easy to use
 • Thermo-cork
 • Longer shape
 • Top-strap distance 4 cm

STRAPS



ELITE • Ergonomic design
 • Available in 3 different sizes
 • Resistant fabric
 • Double ribbon around the palm for better pole control
 • Buckle adjustable in 4 positions



EVOLUTION • Ergonomic design
 • Available in 4 different sizes
 • Resistant fabric
 • Double ribbon around the palm for better pole control



BIATHLON • Ergonomic design
 • Available in 2 sizes
 • Resistant fabric
 • Right and left
 • Special shape for thumb support



FALCON • Ergonomic design
 • Available in 3 different sizes
 • Resistant fabric
 • Double ribbon around the palm for better pole control
 • Buckle adjustable in 4 positions



ELITE • Ergonomic design
 • Available in 3 different sizes
 • Resistant fabric
 • Double ribbon around the palm for better pole control
 • Buckle adjustable in 4 positions



EVOLUTION • Ergonomic design
 • Available in 4 different sizes
 • Resistant fabric
 • Double ribbon around the palm for better pole control



RENTAL • Available in 2 sizes
 • Resistant fabric
 • For beginners or rent

NORDIC POLES STRAPS SIZES

	ELITE CLIP	EVOLUTION CLIP
Measures in cm	XS	80 – 120
	S	122.5 – 142.5
	M/L	145 – 170
	XL	172.5 – 185

DISKS & TIPS



QCD • ø 8.5 and 9.5 mm
 • Original design
 • Quickly removable disk
 • Compatible with qcd winter system
 • Available trekking/rollerski tip



FORZA • ø 8.5 or 9.5 mm
 • Super light
 • Well-visible on snow
 • Best shape for the impact on the snow and for force transmission
 • Special plastic: cold and impact resistant
 • Suitable for all types of snow



Elite • ø 8.5 mm
 • Super light
 • Visible on the snow
 • Best shape for the impact on the snow and for force transmission
 • Special plastic: cold and impact resistant



TITANIUM • Titanium tip
 • Extra light
 • Resistant



SnowTour • Swinging disk for fresh snow
 • Original design
 • Quickly removable disk
 • Compatible with qcd winter system
 • ø 8.5 and 9.5 mm



FIOCCO • ø 9.5 mm
 • Super light
 • Best shape for the impact on the snow and for force transmission
 • Special plastic: cold and impact resistant



BLIZZARD • ø 9.5 mm
 • Super light
 • Best shape for the impact on the snow and for force transmission
 • Special plastic: cold and impact resistant

NORDIC POLES

KVFF

WINTER 2024/25

KVFF WINTER 2024/25 CATALOGUE

PRO RACING

NORDIC POLES

7



HARALD
OSTBERG
AMUNDSEN

TORNADO LIGHT CARBON TITAN

25P001Q

Material: 100% carbon;
62 g/m (+/- 2 g/m)
Length: 130-180 cm
Steps of 2.5 cm

Shaft: 25P414
Handle: 7P103.17 (ø 16.5 mm)
Strap: 23P200
Insert & Nut: 8P302 (ø 8.5 mm)
Tip: 20P331; 9P318



TORNADO LIGHT TITAN

25P023Q

Material: 100% carbon;
62 g/m (+/- 2 g/m)
Length: 130-180 cm
Steps of 2.5 cm

Shaft: 25P414
Handle: 22P104.17 (ø 16.5 mm)
Strap: 23P200
Insert & Nut: 8P302 (ø 8.5 mm)
Tip: 20P331; 7P325



TORNADO PLUS TITAN

23P002Q

WITH TITAN TIPS

23P003Q

WITH CARBIDE TIPS

Material: 100% carbon;
66 g/m (+/- 3 g/m)
Length: 130-185 cm
Steps of 2.5 cm

Shaft: 23P400
Handle: 22P104.17 (ø 16.5 mm)
Strap: 23P200
Insert & Nut: 8P302 (ø 8.5 mm)
Tip for 23P002Q: 20P331; 7P325
Tip for 23P003Q: 20P324

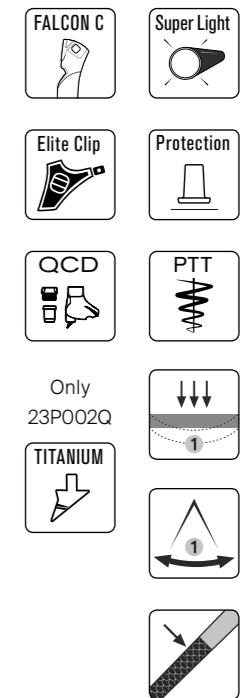

Only
23P002Q

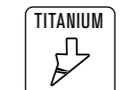

Only
23P002Q

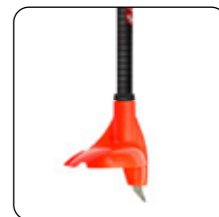

TORNADO PINK

23P004QP

Material: 100% carbon; 66 g/m**Length:** 130-180 cm

Steps of 2.5 cm

Shaft: 23P400P**Handle:** 22P104.17 (ø 16.5 mm)**Strap:** 23P200.P**Insert & Nut:** 8P302 (ø 8.5 mm)**Tip:** 20P324.P

STORM

24P017Q

Material: 100% carbon; 66 g/m**Length:** 130-185 cm

Steps of 2.5 cm

Shaft: 24P418**Handle:** 22P104.17 (ø 16.5 mm)**Strap:** 23P200**Insert & Nut:** 8P302 (ø 8.5 mm)**Tip:** 20P324

BORA

22P005Q

Material: 100% carbon;
71 g/m (+/- 3 g/m)
Length: 130-185 cm
Steps of 2.5 cm

Shaft: 22P402
Handle: 22P104.17 (ø 16.5 mm)
Strap: 23P200
Insert & Nut: 8P302 (ø 8.5 mm)
Tip: 20P324

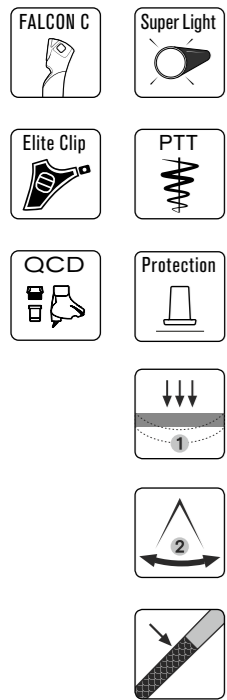

ELITE

25P015Q

Material: 100% carbon;
73 g/m (+/- 3 g/m)
Length: 130-185 cm
Steps of 2.5 cm

Shaft: 23P403
Handle: 23P114.17 (ø 16.5 mm)
Strap: 23P200
Insert & Nut: 8P302 (ø 8.5 mm)
Tip: 20P324.G



TEMPESTA

Material:
100% carbon – 76 g/m
Length: 130-185 cm
Steps of 2.5 cm



23P006

Shaft: 23P404
Handle: 3P100.OR (ø 16.5 mm)
Strap: 9P202
Tip: 4P301.OR (ø 10 mm)



23P006Q

Shaft: 23P404
Handle: 3P100.OR (ø 16.5 mm)
Strap: 9P202
Insert & Nut: 8P323 (ø 10 mm)
Tip: 7P325



TEMPESTA BLUE

Material:
100% carbon – 76 g/m
Length: 130-185 cm
Steps of 2.5 cm



23P007

Shaft: 23P404B
Handle: 3P100.OR (ø 16.5 mm)
Strap: 9P202
Tip: 4P301.OR (ø 10 mm)



23P007Q

Shaft: 23P404B
Handle: 3P100.OR (ø 16.5 mm)
Strap: 9P202
Insert & Nut: 8P323 (ø 10 mm)
Tip: 7P325



VIKING

23P008

Material: 70% carbon – 80 g/m
Length: 125-185 cm
Steps of 2.5 cm

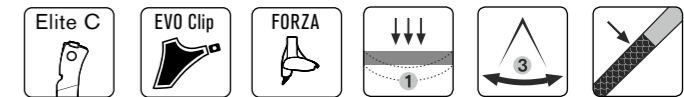

Shaft: 22P404
Handle: 3P100.17 (ø 16.5 mm)
Strap: 9P202
Tip: 3P301 (ø 10 mm)

ADVANCE

23P009

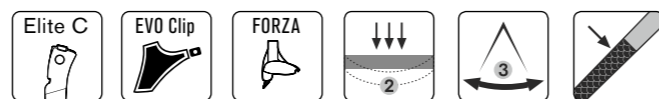
**Material:**

50% carbon – 80 g/m

Length: 110-175 cm

Steps of 2.5 cm

Shaft: 23P406**Handle:** 3P100.17 (ø 16.5 mm)**Strap:** 9P202**Tip:** 3P301 (ø 10 mm)

CAMPRA

23P010

**Material:**

30% carbon for 120–150 cm – 86 g/m

40% carbon for 150–170 cm – 84 g/m

Length: 120-170 cm

Steps of 2.5 cm

Shaft: 23P407**Handle:** 3P100.17 (ø 16.5 mm)**Strap:** 9P202**Tip:** 3P301 (ø 10 mm)

CAMPRA PINK

23P010P

**Material:**

30% carbon for 120–150 cm – 86 g/m

40% carbon for 150–170 cm – 84 g/m

Length: 120-170 cm

Steps of 2.5 cm

Shaft: 23P407P**Handle:** 3P100.17.P (ø 16.5 mm)**Strap:** 9P202**Tip:** 20P301.P (ø 10 mm)

SIMANO C

22P012

**Material:**

30% carbon – 89 g/m

Length: 125-170 cm

Steps of 5 cm

Shaft: 21P415**Handle:** 3P100.17 (ø 16.5 mm)**Strap:** 9P202**Tip:** 3P301 (ø 10 mm)

SIMANO

25P014

**Material:**

30% carbon – 89 g/m

Length: 125-170 cm

Steps of 5 cm

Shaft: 25P415**Handle:** 21P107.17 (ø 16.5 mm)**Strap:** 21P208**Tip:** 21P332 (ø 10 mm)

TORNADO PLUS JUNIOR

Material: 80% carbon – 73 g/m

Length: 110-160 cm

Steps of 2.5 cm



23P003J

Shaft: 23P410

Handle: 3P100.OR (ø 16.5 mm)

Strap: 9P202

Tip: 4P301.OR (ø 10 mm)



23P003JQ

Shaft: 23P410

Handle: 3P100.OR (ø 16.5 mm)

Strap: 9P202

Insert & Nut: 8P323 (ø 10 mm)

Tip: 7P325



TORNADO PLUS JUNIOR PINK

Material: 80% carbon – 73 g/m

Length: 110-160 cm

Steps of 2.5 cm

Shaft: 23P410P

Handle: 3P100.17.P (ø 16.5 mm)

Strap: 9P202

Insert & Nut: 8P323 (ø 10 mm)

Tip: 8P325.P

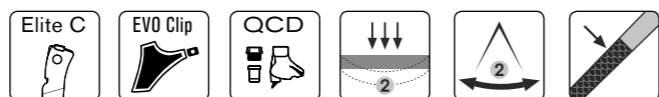

TORNADO JUNIOR

23P010J

Material: 30% carbon – 84 g/m

Length: 90-150 cm

Steps of 2.5 cm

Shaft: 23P411

Handle: 3P100.OR (ø 16.5 mm)

Strap: 9P202

Tip: 4P301.OR (ø 10 mm)



TORNADO JUNIOR PINK

23P010JP

Material: 30% carbon – 84 g/m

Length: 90-150 cm

Steps of 2.5 cm

Shaft: 23P411P

Handle: 3P100.17.P (ø 16.5 mm)

Strap: 9P202

Tip: 20P301.P (ø 10 mm)



FUTURE

21P019J

Material: 10% carbon

Length: 70-140 cm

Steps of 5 cm

Shaft: 21P416

Handle: 21P107.17 (ø 16.5 mm)

Strap: 7P205

Tip: 21P332 (ø 10 mm)

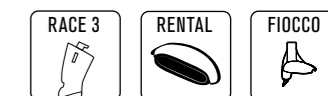



AURÉLIEN GAY

BORA ST

22P011Q

Material: 100% carbon - 62 g/m
Length: 120-145 cm
 Steps of 2.5 cm

Shaft: 22P402
Handle: 7P101.17 (ø 16.5 mm)
Strap: 6P210
Insert & Nut: 8P302 (ø 8.5 mm)
Tip: 9P329

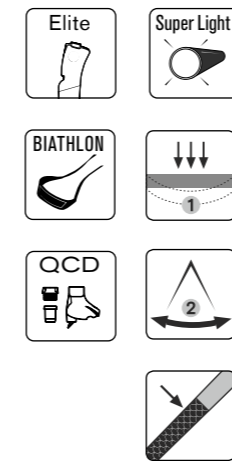

VENTO ST

23P024Q

2 SECTIONS
 TELESCOPE POLE
 (ø 16.5 / 14 mm)

Material: 100% carbon top,
 30% carbon bottom
Length: 115-145 cm
Insert & Nut: 8P323 (ø 10 mm)
Tip: 22P333

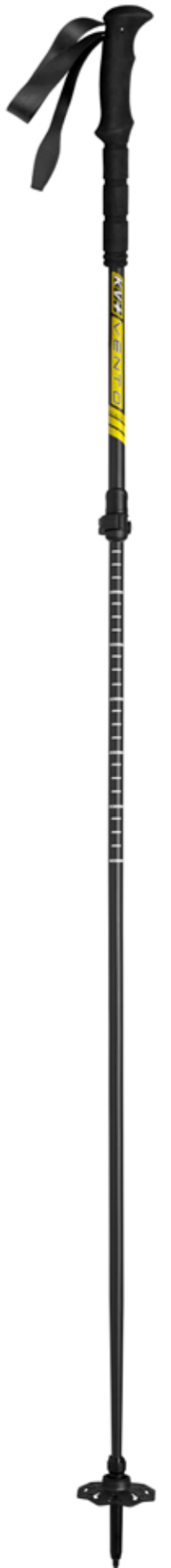
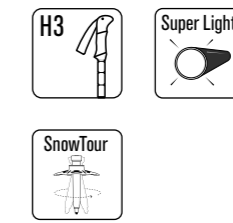



KILIAN
GRANGER

CERVINO QCD

23W16

4 SECTIONS FOLDING POLE
(\varnothing 18 / 16 / 14 / 10 mm)
CLAMP LOCK SYSTEM

Material: 80% carbon
Length: 110-135 cm
Transport length: 46 cm
Weight: 210 g

Insert & Nut: 8P323 (\varnothing 10 mm)
Tip: 9P331
Rubber Tip: 20P316

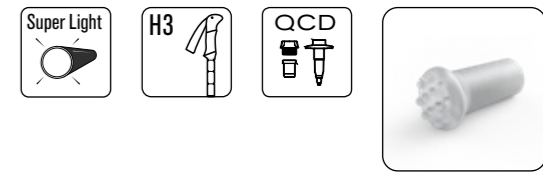

TRINITY QCD

23W14Q

3 SECTIONS TELESCOPE POLE (\varnothing 16.5 / 14 / 8.5 mm)
CLAMP LOCK SYSTEM

Material: 90% carbon
Length: 100-135 cm
Transport length: 62 cm
Weight: 186 g

Insert & Nut: 8P302 (\varnothing 8.5 mm)
Tip: 9P331
Rubber Tip: 20P316

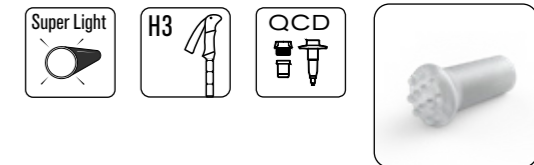

TRINITY-S QCD

24W14SQ

3 SECTIONS TELESCOPE POLE (\varnothing 16.5 / 14 / 8.5 mm)
CLAMP LOCK SYSTEM

Material: 90% carbon
Length: 95-125 cm
Transport length: 40 cm
Weight: 182 g

Insert & Nut: 8P302 (\varnothing 8.5 mm)
Tip: 9P331
Rubber Tip: 20P316

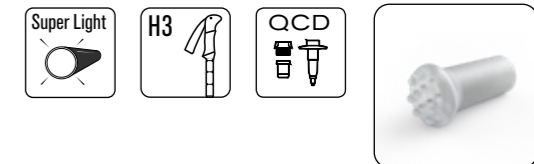

AROSA QCD

9W15UQ



3 SECTIONS TELESCOPE POLE (ø 16.5 / 14 / 10 mm)
CLAMP LOCK SYSTEM

Material: 80% carbon
Length: 100-135 cm
Transport length: 61 cm
Weight: 195 g

Insert & Nut: 8P323 (ø 10 mm)
Tip: 9P331
Rubber Tip: 20P316



AROSA

9W15U



3 SECTIONS TELESCOPE POLE (ø 16.5 / 14 / 10 mm)
CLAMP LOCK SYSTEM

Material: 80% carbon
Length: 100-135 cm
Transport length: 61 cm
Weight: 193 g

Disk 1: 2P312
Disk 2: 2P311
Tip: 2P319 (ø 10 mm)
Rubber Tip: 2P316



AURORA QCD

9W18Q



3 SECTIONS TELESCOPE POLE (ø 18 / 16 / 14 mm)
CLAMP LOCK SYSTEM

Material: Aluminium 70-75
Length: 95-135 cm
Transport length: 61 cm
Weight: 268 g

Insert & Nut: 8P323 (ø 10 mm)
Tip: 9P331
Rubber Tip: 20P316



AURORA

8W18



3 SECTIONS TELESCOPE POLE (ø 18 / 16 / 14 mm)
CLAMP LOCK SYSTEM

Material: Aluminium 70-75
Length: 95-135 cm
Transport length: 61 cm
Weight: 268 g

Disk: 2P311
Tip: 2P319 (ø 10 mm)
Rubber Tip: 2P316



ACCESSORIES

KVFF

WINTER 2024/25

KVFF WINTER 2024/25 CATALOGUE

HANDLES

ACCESSORIES

23



FAST CLIP

23P114.16

Ø 16 mm - 1 pair

23P114.17

Ø 16.5 mm - 1 pair

Weight: 28 g



CARBON CLIP

7P103.17

Ø 16.5 mm - 1 pair

Weight: 19 g



FALCON CLIP

22P104.16

Ø 16 mm - 1 pair

22P104.17

Ø 16.5 mm - 1 pair

22P104.17.B

Ø 16.5 mm - 6 pairs

Weight: 26.5 g



ELITE CLIP

3P100.16

Ø 16 mm - 1 pair

3P100.17

Ø 16.5 mm - 1 pair

3P100.17.B

Ø 16.5 mm - 6 pairs

Weight: 29 g



ELITE CLIP OR

3P100.OR

Ø 16.5 mm - 1 pair

3P100.OR.B

Ø 16.5 mm - 6 pairs

Weight: 29 g



ELITE CLIP PINK

3P100.17.P

Ø 16.5 mm - 1 pair

Weight: 29 g



FALCON

21P109.17

Ø 16.5 mm - 1 pair

Weight: 26 g



ELITE

7P101.16

Ø 16 mm - 1 pair

7P101.17

Ø 16.5 mm - 1 pair

7P101.17.B

Ø 16.5 mm - 6 pairs

Weight: 29 g



RACE 3

21P107.17

Ø 16.5 mm - 1 pair

Weight: 34 g



BAND FOR ELITE CLIP

21P113

1 pair

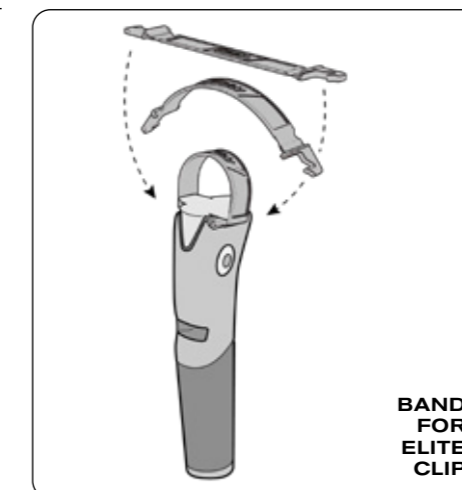

LOCK SYSTEM FALCON CLIP

22P106

1 pair



LOCK SYSTEM FALCON

21P112

1 pair



LOCK SYSTEM FAST CLIP

23P115

1 pair



ADAPTER FOR LENGTH

9P111

1 pair



WEDGES FOR ELITE

7P110

1 pair



WEDGES FOR RACE 3

21P110

1 pair



BIATHLON

6P210

Size: S, M/L
1 pair



BIATHLON 2

21P211

Size: M/L
1 pair



BIATHLON 3

23P212

Size: S, M/L, XL
1 pair



RENTAL

7P205

Size: S, M/L
1 pair



UNIVERSAL CLIP

6P204

One Size
1 pair



ELITE CLIP

23P200

Size: S, M/L, XL
1 pair



ELITE CLIP PINK

23P200P

Size: S, M/L, XL
1 pair



ELITE

23P201

Size: S, M/L, XL
1 pair



FALCON

23P207

Size: S, M/L, XL
1 pair



EVOLUTION CLIP

9P202

Size: XS, S, M/L, XL
1 pair



EVOLUTION

9P203

Size: XS, S, M/L, XL
1 pair



EVO 3

21P208

Size: S, M/L, XL
1 pair



ELITE

3P300

Ø 8.5 mm - 1 pair

3P300.B

Ø 8.5 mm - 6 pairs



ELITE OR

3P300.OR

Ø 8.5 mm - 1 pair

3P300.OR.B

Ø 8.5 mm - 6 pairs

20P300.OR

TITAN - Ø 8.5 mm - 1 pair



FORZA

3P301

Ø 10 mm - 1 pair

3P301.B

Ø 10 mm - 6 pairs



FORZA OR

4P305.OR

Ø 8.5 mm - 1 pair

4P305.OR.B

Ø 8.5 mm - 6 pairs

4P301.OR

Ø 10 mm - 1 pair

4P301.OR.B

Ø 10 mm - 6 pairs



FORZA PINK

20P301.P

Ø 10 mm - 1 pair



BLIZZARD

7P308

Ø 10 mm - 1 pair



BLIZZARD OR

7P308.OR

Ø 8.5 mm - 1 pair



FIOCCO

21P332

Ø 10 mm - 1 pair



VID TIP ROLLERSKI

7P303

Ø 8,5 mm - 1 pair

7P303.B

Ø 8,5 mm - 6 pairs



VID TIP ROLLERSKI EXTRA

7P304

Ø 10 mm - 1 pair

7P304.B

Ø 10 mm - 6 pairs



RUBBER PROTECTION TIP

21P317

1 pair



ROLLERSKI GARA

24P334

Ø 8,5 mm - 1 pair

24P335

Ø 10 mm - 1 pair



VID TIP TRACK

2P319

Ø 10 mm - 1 pair



DISK WINTER

2P312

for: 2P319
Ø 95 mm

TORNADO TIP ROLLERSKI

7P326

1 pair



SNOW TOUR DISK

22P333

1 pair



TIP TREKKING QCD

9P331

1 pair



TORNADO DISK

7P325

BIG - 1 pair



TORNADO DISK GREY

8P325.G

BIG - 1 pair



TORNADO DISK PINK

8P325.P

BIG - 1 pair



20P324

SMALL - 1 pair



20P324.G

SMALL - 1 pair



20P324.P

SMALL - 1 pair



TORNADO ROLLERSKI GARA

24P336

1 pair



DISK XS

9P318

1 pair



DISK XL

9P329

1 pair

QUICK CHANGE DISK & TIP
COMPLETE SET

8P327

Ø 8.5 mm - 3 pairs

8P328

Ø 9.5 mm - 3 pairs



KEY FOR QCD

Help for opening/closing QCD nuts

9P330

1 piece

BASE INSERT & NUT
FOR SHAFTS

8P302

Ø 8.5 mm - 1 pair

8P323

Ø 9.5 mm - 1 pair



SKI BAG

23D08

Up to 3 pairs of skis
Fabric: 100% Polyester
Length: 208 cm
Height: 24 cm
Depth: 13 cm

**BIG SKI BAG**

23D09

Length: 200 cm

23D21

Length: 210 cm

Up to 6 pairs of skis
Fabric: 100% Polyester

**POLE BAG**

23D03

Up to 3 pairs of poles
Fabric: 100% Polyester
Length: 180 cm
Height: 14 cm
Depth: 14 cm

**RIGID POLE BAG**

22D10

Up to 5 pairs of poles
Fabric: 100% Polyester
Length: 150-195 cm
 adjustable
Ø: 15 cm

**SMALL RIGID POLE BAG**

22D19

Up to 2 pairs of poles
Fabric: 100% Polyester
Length: 150-195 cm
 adjustable
Ø: 10 cm

**ROLLERSKI BAG**

22D17

Up to 4 pairs of rollerskis
Fabric: 100% Polyester
Length: 84 cm
Height: 16 cm
Depth: 19 cm



RUCKSACK BLACK 30L

24D15.12

Fabric: 100% Polyester
Dimensions: 58x34x21 cm
Volume: 30 L
Weight: 0.9 kg
 Straps for compression



PIONEER BACKPACK

23D29

Backpack without water bladder
Volume: 5 L



RUCKSACK BLACK 35L

24D14.12

Fabric: 100% Polyester
Dimensions: 52x32x23 cm
Volume: 35 L
Weight: 0.9 kg
 Straps for compression



RUCKSACK 45L

24D22.12

Fabric: 100% Polyester
Dimensions: 59x48x38 cm
Volume: 45 L
Weight: 1.3 kg
 Straps for compression
 Protective cover



BIG TROLLEY BAG 120L

25D12.12

Fabric: 100 % Polyester
Dimensions: 80x38x30 cm
Volume: 120 L
Weight: 4.0 kg
 Straps for compression



CROSS-SKATER BAG

23D22

Fabric: 100 % Polyester
Dimensions: 78x40x35 cm



WAIST BAG

23D07A



WAIST BAG WITH THERMO BOTTLE

23D07



THERMO BOTTLE

Volume: 500 ml

5D07B



WATER BOTTLE

Stainless steel
Volume: 500 ml

24D40



THERMO COVER

For water bladder

7D23

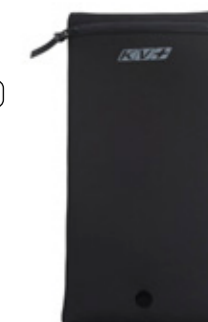

WATER BLADDER FOR WAIST BAG MARATHON

24D39

For waist bag
Volume: 1.2 litre



COVER GASKET FOR WAIST BAG

24D35

Gasket for:
 22D26, 22D05, 22D32, 23D34



TRANSFORMER BAG

6D28.12

Fabric: 100% Polyester
Dimensions: 24x17x5 cm



EASY BAG

21D31

Fabric: 100% Polyester
Dimensions: 75x55 cm





THERMO WAIST BAG WITH LED

22D32

Volume: 1 litre



THERMO WAIST BAG REFLEX

23D34

Volume: 1 litre



THERMO WAIST BAG

25D05.14

Volume: 1 litre



WAIST BAG MARATHON WITH WATER BLADDER

24D38

Volume: 1.2 litre



22D05

Volume: 1 litre



TOOL FOR SHAFTS CUTTING

22D33

Special clamp designed to cut 2 shafts at the same time, saving the carbon fibre structure and the topcoat.

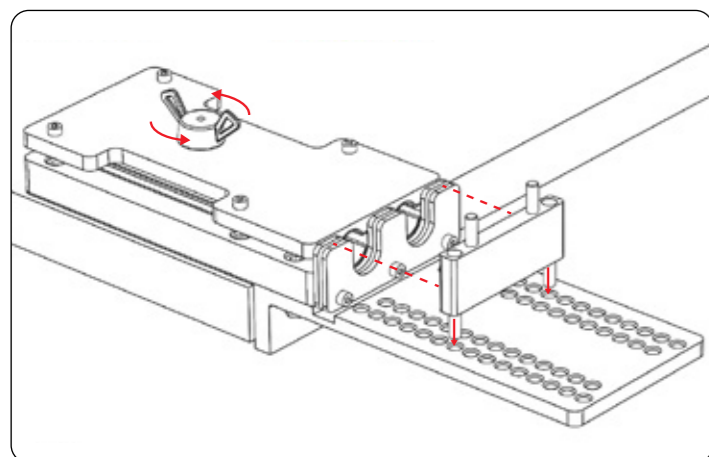

1. Place the cutting tool on stable plane (a standard clamp can also be used on side in the appropriate space)
2. Unscrew the central knob (without remove it)
3. Position the end-stop according to the desired cutting size (the interval between the holes is of 5mm)

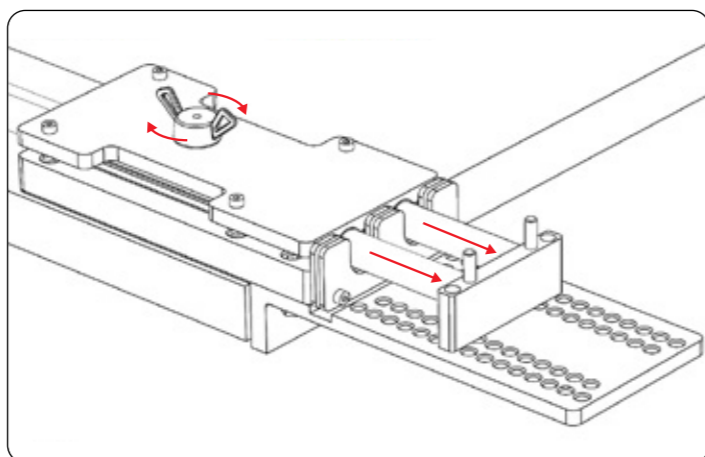

4. Insert the shafts right up against the end-stop
5. Screw the central knob to lock the shafts
6. Remove the end-stop

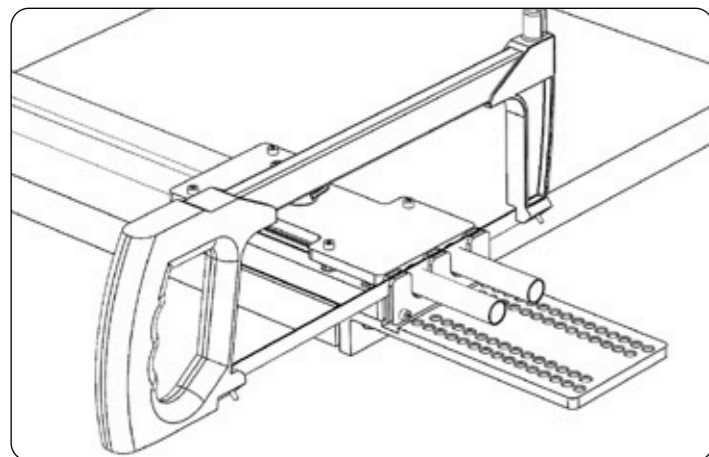

7. Cut with an appropriate saw (if you need you can adjust the distance between guides)

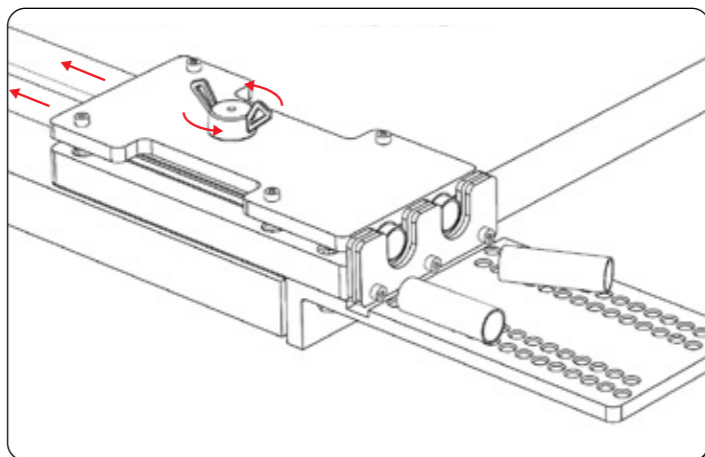

8. Unscrew the central knob to remove the shafts.
9. Enjoy your shafts with perfect length.

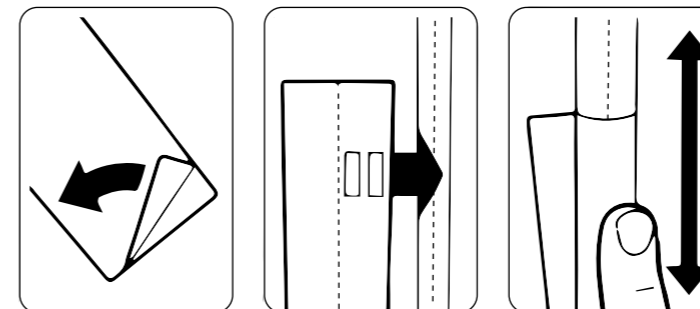

1. Clean pole's surface using alcohol or other degreaser.
2. Peel the film off from underlay.
3. Align film's central line with pole's shaft centre.
4. For maximum protection, place the film as close as possible to the pole's end.
5. Press the film down with your finger along central line.
6. Keep pushing it down and smoothing it out from centre to sides, avoiding air bubbles.

PROTECTION FILM APPLICATION & USE RECOMMENDATIONS

PROTECTION FILM FOR SHAFTS

1 pair

6P050



POLES HOLDER

For 1 pair of poles

23D36



KV+ PROLINK PRO CLASSIC

L4167270001



KV+ PROLINK PRO SKATE

L4167260001



KV+PROLINK ACCESS CLASSIC

L4049930001



KV+ PROLINK ACCESS SKATE

L4049920001



KV+ PROLINK ACCESS JR CLASSIC

L4057100001



KV+ PROLINK RACE JR SKATE

L4057090001



FORZA SKATE / FORZA CLASSIC



Component:

- Cap sheet
- Glass laminate
- Carbon-glass laminate
- Paulownia poplar core
- Sintered uhm graphite base

FORZA SKATE CROSS COUNTRY SKI

Article n°	24SK03.MP Forza skate RS 3.0 / medium plus	Length: 173 cm 180 cm 187 cm 194 cm	Weight: 581 g/Ski 639 g/Ski 664 g/Ski 714 g/Ski	Sidecut: Tip 43 mm Waist 45 mm Tail 45 mm
	24SK03.HP Forza skate RS 3.0 / hard plus	Variation: Plus	Stiffness: Medium Hard	Binding: Rottefella

FORZA CLASSIC CROSS COUNTRY SKI

Article n°	24CL03.MP Forza classic RS 3.0 / medium plus	Length: 179 cm 186 cm 193 cm 200 cm 207 cm	Weight: 622 g/Ski 675 g/Ski 697 g/Ski 704 g/Ski 764 g/Ski	Sidecut: Tip 43 mm Waist 45 mm Tail 45 mm
	24CL03.HP Forza classic RS 3.0 / hard plus	Variation: Plus	Stiffness: Medium Hard	Binding: Rottefella

TORNADO SKATE



Component:

- Cap sheet
- Glass laminate
- Carbon-glass laminate
- Paulownia poplar torsion box
- Aramid honey-comb
- Sintered uhm graphite base

TORNADO SKATE CROSS COUNTRY SKI

Article n°	24SK01.MP Tornado skate RS 1.0 / medium plus	Length: 177 cm 182 cm 187 cm 192 cm	Weight: 494 g/Ski 508 g/Ski 538 g/Ski 567 g/Ski	Sidecut: Tip 41 mm Waist 44 mm Tail 44 mm
	24SK01.HP Tornado skate RS 1.0 / hard plus	Variation: Plus Cold	Stiffness: Medium Hard	Binding: Xcelerator 2.0 Skate
24SK01.HC Tornado skate RS 1.0 / hard cold				

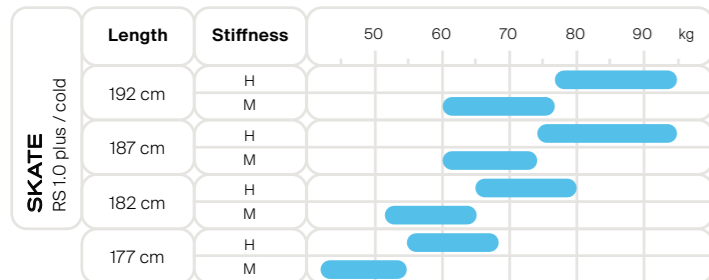
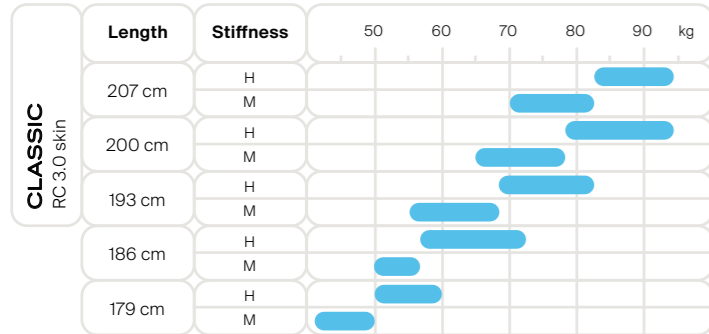
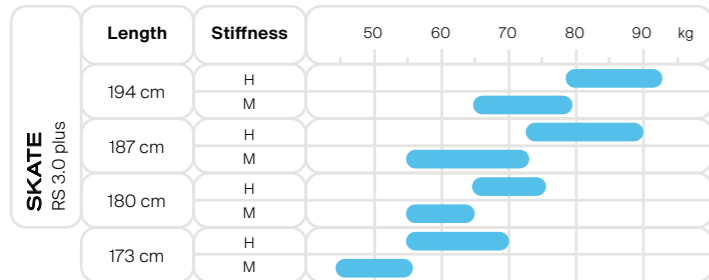

TORNADO XC SKI SKATE

Tornado skate RS 1.0

Color: Blue / Red / Black
Length: 177 / 182 / 187 / 192

- 24SK01.MP** MEDIUM PLUS
- 24SK01.MC** MEDIUM COLD
- 24SK01.HP** HARD PLUS
- 24SK01.HC** HARD COLD



FORZA XC SKI CLASSIC

Forza classic RS 3.0

Color: Blue / Red / Black
Length: 179 / 186 / 193 / 200 / 207

- 24CL03.MP** MEDIUM PLUS
- 24CL03.HP** HARD PLUS



FORZA XC SKI SKATE

Forza skate RS 3.0

Color: Blue / Red / Black
Length: 173 / 180 / 187 / 194

- 24SK03.MP** MEDIUM PLUS
- 24SK03.HP** HARD PLUS



SKI CLIP

1 piece

- 25D06**
- 25D06.CH**
- 25D06.N**



- 25D06.S**
- 25D06.F**
- 25D06.CAN**
- 25D06.US**



XC SHOES

KV+

WINTER 2024/25

KV+ WINTER 2024/25
CATALOGUE

XC SHOES

39

TORNADO LIGHT SKATE

Colour: Black ; Blue / Red

Size: 38–46

Sole: Rottefella SSR V2

Features: Race last, elite cuff,
carbon outsole with plastic support
in front, Rottefella heel SSR V2,
45° lacing system, tx-loop lacing,
anatomic footbed, stiff flex



25BT06.1

TORNADO SKATE

Colour: Black / Grey ; Blue / Red

Size: 35–48

Sole: XCELERATOR SKATE

Features: Race last, elite cuff,
plastic heel counter with carbon
stabilizer gaiter built-in elastic insert
45° lacing system, tx-loop lacing,
anatomic footbed, stiff flex.



24BT01.2



24BT01.1

TORNADO CLASSIC

Colour: Black / Grey ; Blue / Red

Size: 35–48

Sole: XCELERATOR CLASSIC

Features: Race last,
plastic heel counter gaiter,
90° lacing system tx-loop lacing
anatomic footbed soft flex



24BT02.2



24BT02.1

CH5 SKATE

Colour: Black / Grey / Blue

Size: 35–48

Sole: T4

Features: Plastic for
heel counter adjustment



22BT03

CH5 CLASSIC

Colour: Black / Grey / Blue

Size: 35–48

Sole: T4



22BT04

TREKKING SHOES



WINTER 2024/25

FEATURES



MEDIUM UPPER
Upper which goes no higher than your ankle

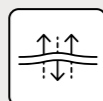

BREATHABLE
Ability of the fabric to allow perspiration evaporated by the foot, to escape outside (termed moisture vapour transmission), thereby allowing complete comfort



TWIST-LOCK FASTENING
Lock system without laces. Simple one hand operation: pull up twist-lock to open the shoes, push down twist-lock and fine-tune by turning.



LOW UPPER
Upper with standard height for everyday use



WATER-PROOF
A special substance is put on the surface of the upper in order not to let water pass through it and consequently keeps your foot dry in all weather conditions



QUICK LOCK LACES
Stretch quick lacing system without tying



TRAIL GRIP
Friction and traction quality of the outsole, quality of the contact area on roads and/or rocky terrain



WARMTH
Quality to keep a constant warm in temperature inside the shoe



HIGH ERGONOMIC SYSTEM



SPIKES SOLE
Outsole provided with metal spikes for a better grip on rocky and/or icy tracks



CUSHIONING
Soft and resilient material of the sole gives shape, adds comfort and provides the best protection of the foot against force or shock.



VIBRAM SOLE



RUNNING SOLE
Soles especially designed for running, light with extra cushioning for heel and toe.

KIV WINTER 2024/25 CATALOGUE

TREKKING SHOES

41

DAKOTA BLACK

24BT26.1

Colour: Black
Size: 36—46
Features: Water-proof

Upper material: TPU /MESH Water-proof
Outsole: MD+TPR



DAKOTA BLACK VIBRAM

24BT30.1

Colour: Black
Size: 36—46
Features: Water-proof

Upper material: TPU /MESH Water-proof
Outsole: Vibram



DAKOTA SPIKE

24BT23.1

Colour: Black
Size: 36—46
Features: Water-proof; Free-lock system; Spike outsole

Upper material: TPU /MESH Water-proof
Outsole: MD+RB+SPIKE



DELTA

24BT22.1

Colour: Black/Beige
Size: 36—46
Features: Water-proof

Upper material: Non-Sewn-TPU /Nylon-net/Airmesh
Outsole: EVA+RB



24BT22.15



CRESTA

24BT25.8



Colour: Petrol; Grey; Beige
Size: 36–46
Features: Water-proof

Upper material: MESH/TPU/PU
Outsole: MD+TPR



24BT25.15



24BT25.9

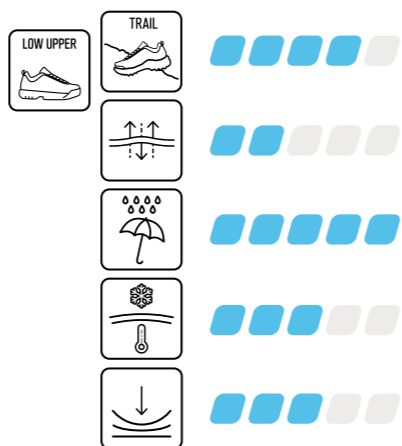

SPIKE

24BT24.1



Colour: Black
Size: 36–46
Features: Water-proof; Free-lock system; Spike outsole

Upper material: softshell+TPU
Outsole: MD+RB+SPIKE

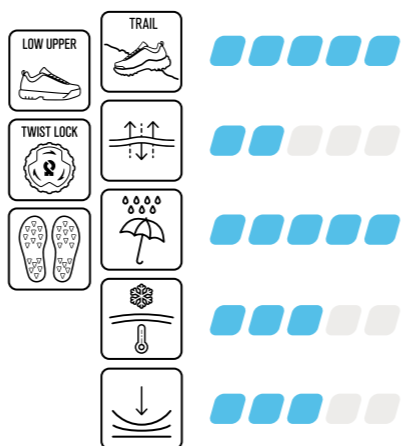

ALPS

24BT20.2



Colour: Blue / Black
Size: 36–46
Features: Water-repellent

Upper material: Non-Sewn-TPU /Airmesh
Outsole: EVA+CPU

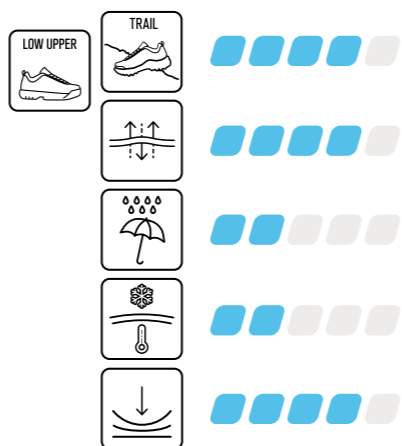

FOCA

24BT28.2



Colour: Blue
Size: 36–46
Upper material: knited-mesh/3D printing /rubber-piece/mesh
Outsole: printing-MD+TPR

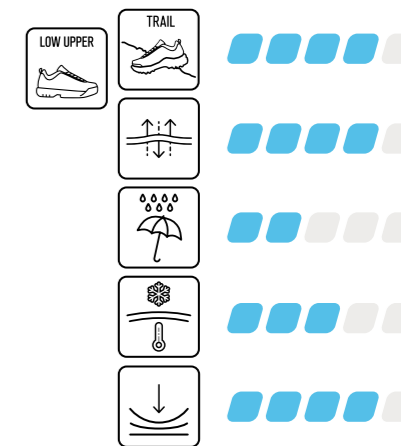

FOCA VIBRAM

24BT29.2



Colour: Blue
Size: 36–46
Upper material: knited-mesh/3D printing /rubber-piece/mesh
Outsole: Vibram

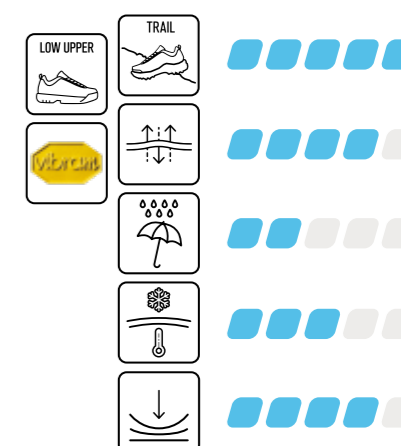

ALPHA

24BT21.2



Colour: Blue
Size: 36–46
Upper material: Non-Sewn-TPU/Airmesh
Outsole: EVA+CPU
Features: Water-proof

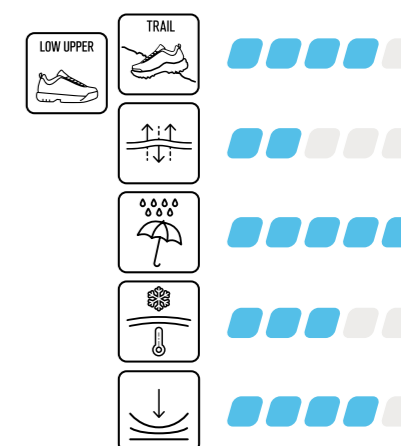

BREEZE

24BT27.2



Colour: Blue
Size: 36–46
Upper material: RIP-STOP+TPU FILM
Outsole: MD+TPR
Features: Water-repellent

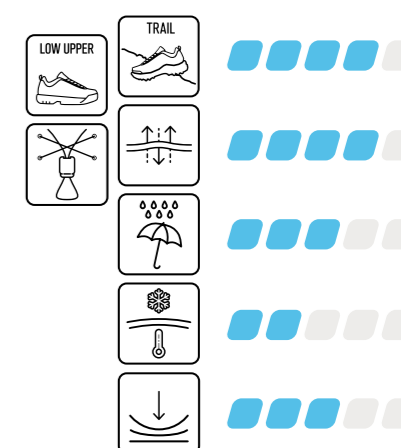



WINTER 2024/25



ALPHA EYEWEAR SOLID COLOR

SG15.14

Frame: Lilac
 • Adjustable nose pads
Provided with: EVA box



LENSES	UV 400 PROTECTION	POLY-CARBONATE	POLARIZED	ANTI-FOG	VENT LENS	VISIBLE LIGHT TRANSMISSION
BARBIE PINK	•	•		•		CAT 3

SG15.1

Frame: Black matt
 • Adjustable nose pads
 • 2 set lens
Provided with: EVA box



LENSES	UV 400 PROTECTION	POLY-CARBONATE	POLARIZED	ANTI-FOG	VENT LENS	VISIBLE LIGHT TRANSMISSION
GLACIER BLUE	•	•	•	•		CAT 3

LENSES	UV 400 PROTECTION	POLY-CARBONATE	POLARIZED	ANTI-FOG	VENT LENS	VISIBLE LIGHT TRANSMISSION
CW36				•	•	CAT 0

SG15.2

Frame: Blue
 • Adjustable nose pads
 • 2 set lens
Provided with: EVA box



LENSES	UV 400 PROTECTION	POLY-CARBONATE	POLARIZED	ANTI-FOG	VENT LENS	VISIBLE LIGHT TRANSMISSION
SHINNY SILVER	•	•		•		CAT 3

LENSES	UV 400 PROTECTION	POLY-CARBONATE	POLARIZED	ANTI-FOG	VENT LENS	VISIBLE LIGHT TRANSMISSION
CW36				•	•	CAT 0

SG15.21

Frame: Mint green
 • Adjustable nose pads
 • 2 set lens
Provided with: EVA box



LENSES	UV 400 PROTECTION	POLY-CARBONATE	POLARIZED	ANTI-FOG	VENT LENS	VISIBLE LIGHT TRANSMISSION
SHINNY SILVER	•	•		•		CAT 3

LENSES	UV 400 PROTECTION	POLY-CARBONATE	POLARIZED	ANTI-FOG	VENT LENS	VISIBLE LIGHT TRANSMISSION
CW36				•	•	CAT 0

ALPHA EYEWEAR LENS SPECIAL REVO

SG15.12

Frame: Pink Crystal (Grilamid TR90)
 • Adjustable nose pads
Provided with: EVA box



LENSES	UV 400 PROTECTION	POLY-CARBONATE	POLARIZED	ANTI-FOG	VENT LENS	VISIBLE LIGHT TRANSMISSION
PEACH RED	•	•		•	•	CAT 3

SG15.4

Frame: Blue Crystal (Grilamid TR90)
 • Adjustable nose pads
Provided with: EVA box



LENSES	UV 400 PROTECTION	POLY-CARBONATE	POLARIZED	ANTI-FOG	VENT LENS	VISIBLE LIGHT TRANSMISSION
CRYSTAL PURPLE	•	•		•	•	CAT 3

SG15.91

Frame: Grey Crystal (Grilamid TR90)
 • Adjustable nose pads
Provided with: EVA box



LENSES	UV 400 PROTECTION	POLY-CARBONATE	POLARIZED	ANTI-FOG	VENT LENS	VISIBLE LIGHT TRANSMISSION
CRYSTAL PURPLE	•	•		•	•	CAT 3

SG15.9

Frame: Grey Crystal (Grilamid TR90)
 • 2 set lens
 • Photochromatic
 • Adjustable nose pads
Provided with: EVA box



LENSES	UV 400 PROTECTION	POLY-CARBONATE	POLARIZED	ANTI-FOG	VENT LENS	VISIBLE LIGHT TRANSMISSION
CRYSTAL PURPLE	•	•		•	•	CAT 3
PHOTO-CHROMIC	•	•		•	•	CAT 3



SG15.15

Frame: Warm Grey Crystal (Grilamid TR90)
 • Adjustable nose pads
Provided with: EVA box



LENSES	UV 400 PROTECTION	POLY-CARBONATE	POLARIZED	ANTI-FOG	VENT LENS	VISIBLE LIGHT TRANSMISSION
ROSEGOLD	•	•	•	•		CAT 3

VERTICAL

SG13.1

Frame: Black (Grilamid TR90)
 • Adjustable nose pads
Provided with: microfiber bag



LENSES	UV 400 PROTECTION	POLY-CARBONATE	POLARIZED	ANTI-FOG	VENT LENS	VISIBLE LIGHT TRANSMISSION
CW36 SKY RED REVO	•	•				CAT 3

SG13.2

Frame: Blue (Grilamid TR90)
 • Adjustable nose pads
Provided with: second spare lens + microfiber bag + window box



LENSES	UV 400 PROTECTION	POLY-CARBONATE	POLARIZED	ANTI-FOG	VENT LENS	VISIBLE LIGHT TRANSMISSION
CW56 SKY BLUE REVO	•	•	•	•		CAT 3
CW36 RED REVO	•	•		•		CAT 3

TICINO

SG14.1

Frame: Black, Grey (Grilamid TR90)
Provided with: microfiber bag



LENSES	UV 400 PROTECTION	POLY-CARBONATE	POLARIZED	ANTI-FOG	VENT LENS	VISIBLE LIGHT TRANSMISSION
CW36 RED IRIDESCENT	•	•		•		CAT 3

SG14.5

Frame: Orange, Red (Grilamid TR90)
Provided with: microfiber bag



LENSES	UV 400 PROTECTION	POLY-CARBONATE	POLARIZED	ANTI-FOG	VENT LENS	VISIBLE LIGHT TRANSMISSION
CW36 RED REVO	•	•	•	•		CAT 3

SG14.7

Frame: Grey, Lime, Black (Grilamid TR90)
Provided with: microfiber bag



LENSES	UV 400 PROTECTION	POLY-CARBONATE	POLARIZED	ANTI-FOG	VENT LENS	VISIBLE LIGHT TRANSMISSION
CW31 YELLOW REVO	•	•				CAT 3



APPAREL

KVZ

WINTER 2024/25





STRETCH FABRIC – A classic double opposite interlace warp knitted fabric weighting 190 g/m²-80/20, produced using multifilament super dull polyester yarns and elastomer.



(EN) Bonded tape seam - (DE) Geklebttes Nahtband - (FR) Ruban de couture adhesif collé - (IT) Cucitura incollata - (RU) Клееный шов



SUPER ROUBAIX – The remarkable perspiration, burst, elasticity, comfort features combined with the soft and swollen handfeel of the brushing the unquestionable resistance also to strong uses and the easy maintenance, make it a real and undisputed reference point in the stretch brushed fabrics. Fabric suggested both far competitive uses and active-wear, outdoor, leisure and fashion clothing.



(EN) Flat- lock seam - (DE) Flache Naht - (FR) Couture plate - (IT) Cucitura piatta - (RU) Клееный шов



(EN) Overlock seam - (DE) Overlock Naht - (FR) Couture overlock - (IT) Cucitura overlock - (RU) Шов«оверлок»



WIND PROTECT – Maximum protection from wind and good water repellency. Suitable for cold climates. Naturally repellent does not mean completely Water-proof.



(EN) Stitching seam - (DE) Doppelnadelstich - (FR) Couture double aiguille - (IT) Impuntura - (RU) Двойной шов



Water-repellent – A term applied to fabrics that have been treated with a finish which causes them to shed water, but are still air-permeable.



(EN) Reflex tape- (DE) Reflektierender Tape- (FR) Bande réfléchissante- (IT) Nastro rifrangente - (RU) Светоотражающая полоска



WATER- WIND PROTECT – A term applied to fabrics whose pores have been closed and therefore will not allow water or air to pass through them



(EN) Reflex zipper - (DE) Reflektierender Reissverschluss - (FR) Zip réfléchissant - (IT) Cerniera rifrangente - (RU) Светоотражающая молния



SEAMLESS – Seamless yarn is the first high-performance specifically designed for use with seamless technology. Softly joined like a second skin to offer seamless garments in the best performance in terms of comfort, fit, freedom of movement, ease of cleaning and a good dimensional stability.



(EN) Open end zipper- (DE) Open-end Reissverschluss- (FR) Zip ouvrable - (IT) Cerniera arabile - (RU) Разъемная молния



(EN) 2- way separating zipper - (DE) Zweiweg-Reissverschluss - (FR) Zip à 2 glissières séparées - (IT) Cerniera a 2 cursori separati - (RU) Двухсторонняя разъемная молния



ANTIBACTERIA – This fabric has been studied to obtain maximum hygienic protection, with antimicrobial and antibacterial action. The effective active-defense against a large spectrum of micro-organism such as bacteria, fungus and moulds, guarantees freshness and hygiene for the body, preventing bad odors and many allergic effects.



(EN) Inside facing- (DE) Abdeckung innere Deckschicht - (FR) Couche protectrice interne - (IT) Paramontura interna - (RU) Закрытая застёжка



(EN) Adjustable waist - (DE) Verstellbarer bund - (FR) Taille réglable - (IT) Vita regolabile - (RU) Регулировщик шнурка на талии



THERMO PROTECTION – Thermo protection fabric allows the perfect regulation of body's temperature.



(EN) One pocket - (DE) Eine Tasche - (FR) Une poche - (IT) Una tasca - (RU) Один карман



(EN) Praformed knee - (DE) Vorgeformte Knie - (FR) Genou préformé - (IT) Ginocchio preformato - (RU) Анатомический покррой колена



(EN) Multi pockets - (DE) Mehrere Taschen - (FR) Poches multiples - (IT) Più tasche - (RU) Несколько карманов



(EN) Removable braces - (DE) Abnehmbare Hosenträger - (FR) Bretelles amovibles - (IT) Bretelle removibili - (RU) Отстёгивающийся лямки



(EN) Removable hood - (DE) Abnehmbare kapuze - (FR) Capuchon amovible - (IT) Cappuccio removibile - (RU) Отстегивающийся капюшон



(EN) Close fitting - (DE) Atletische Passform- (FR) Coupe moulante - (IT) Linea attillata - (RU) Облегающий крой



(EN) Elastic cuff - (DE) Elastisches Bündel - (FR) Manchette élastique - (IT) Polsino elastico - (RU) Эластичный манжет



(EN) Loose fitting - (DE) Locker geschnittene Passform - (FR) Coupe ample - (IT) Linea ampia - (RU) Свободный крой



(EN) Silicon elastic gripper - (DE) Elastisches Silicon-Gripband - (FR) Bande élastique en silicone - (IT) Elastico con silicone - (RU) Силиконовая лента



(EN) padded jacket - (DE) gefütterte Jacke (FR) veste matelassée - (IT) giubbotto imbottito - (RU) мягкая куртка

REFERENCE SIZES

		XS	S	M	L	XL	XXL	3XL
Man	Height		165–170	170–175	175–180	180–185	185–190	190–195
	Chest		89–94	94–99	99–104	105–109	109–114	114–119
	Waist		70–75	75–80	80–85	85–90	90–95	95–100
Woman	Height	155–160	160–165	165–170	170–175	175–180		
	Chest	75–80	80–90	90–95	95–100	100–105		
	Waist	65–70	70–75	75–80	80–85	85–90		
Unisex	Height	160–165	165–170	170–175	175–180	180–185	185–190	190–195
	Chest	78–85	85–92	92–99	99–104	105–109	109–114	114–119
	Waist	65–70	70–75	75–80	80–85	85–90	90–95	95–100

COLOUR CODES

0	1	2	3	4	5	6	7	8	9	11	12	13
White	Black	Blue	Red	Navy	Orange	Bordeaux	Green	Petrol	Grey	Anthracite	Pink	Yellow



TORNADO TWO PIECES SUIT UNISEX

Fabric: 82% Polyester, 18% Spandex
Size: XS, S, M, L, XL, XXL, 3XL



24V118.21

Black / Turquoise



23V118.3

Black / Red / White

23V118.20

Blue / White



TORNADO JACKET MAN

Fabric: 92% Polyester, 8% Spandex
Size: S, M, L, XL, XXL, 3XL



24V104.21

Black / Turquoise



25V104.41

Blue / Black



24V104.4

Dark Blue



24V104.3

Black / Red

TORNADO JACKET WOMAN

Fabric: 92% Polyester, 8% Spandex
Size: XS, S, M, L, XL



24V107.21

Black / Turquoise



25V107.25

Blue / Pastel pink



24V107.14

Black / Lilac



24V107.04

White / Lilac

TORNADO VEST MAN

Fabric: 92% Polyester, 8% Spandex
Size: S, M, L, XL, XXL, 3XL



24V102.21
Black / Turquoise



25V102.41
Blue / Black



TORNADO PANTS MAN

Fabric: 92% Polyester, 8% Spandex
Size: S, M, L, XL, XXL, 3XL

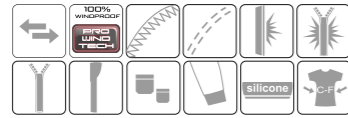

22V105.1
Black



24V105.4
Dark Blue



TORNADO SHORTS MAN

Fabric: 60% Polyester, 33% Polyurethane, 7% Spandex
Size: S, M, L, XL, XXL, 3XL

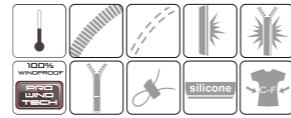

23V123.1
Black



TORNADO VEST WOMAN

Fabric: 92% Polyester, 8% Spandex
Size: XS, S, M, L, XL



24V103.21
Black / Turquoise



24V103.14
Black / Lilac



TORNADO PANTS WOMAN

Fabric: 92% Polyester, 8% Spandex
Size: XS, S, M, L, XL

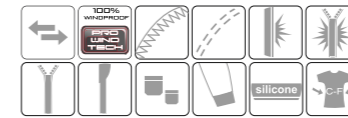

22V108.1
Black



TORNADO SHORTS WOMAN

Fabric: 60% Polyester, 33% Polyurethane, 7% Spandex
Size: XS, S, M, L, XL

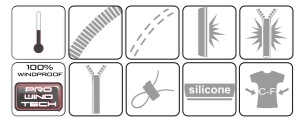

23V124.1
Black



PREMIUM JACKET
UNISEX

Pro-wind-tech fabric:
90% Polyester, 10% Spandex
Size: XS, S, M, L, XL, XXL, 3XL



24V145.40

Navy / White



23V145.3

Red / Black / White



25V145.9

Dark Grey / Beige



25V145.2

Blue



25V145.7

Green

PREMIUM PANTS
UNISEX

Pro-wind-tech fabric:
90% Polyester, 10% Spandex
Size: XS, S, M, L, XL, XXL, 3XL



23V146.1

Black



23V146.4

Navy



25V146.9

Dark Grey



23V147.1

Full Zip - Black



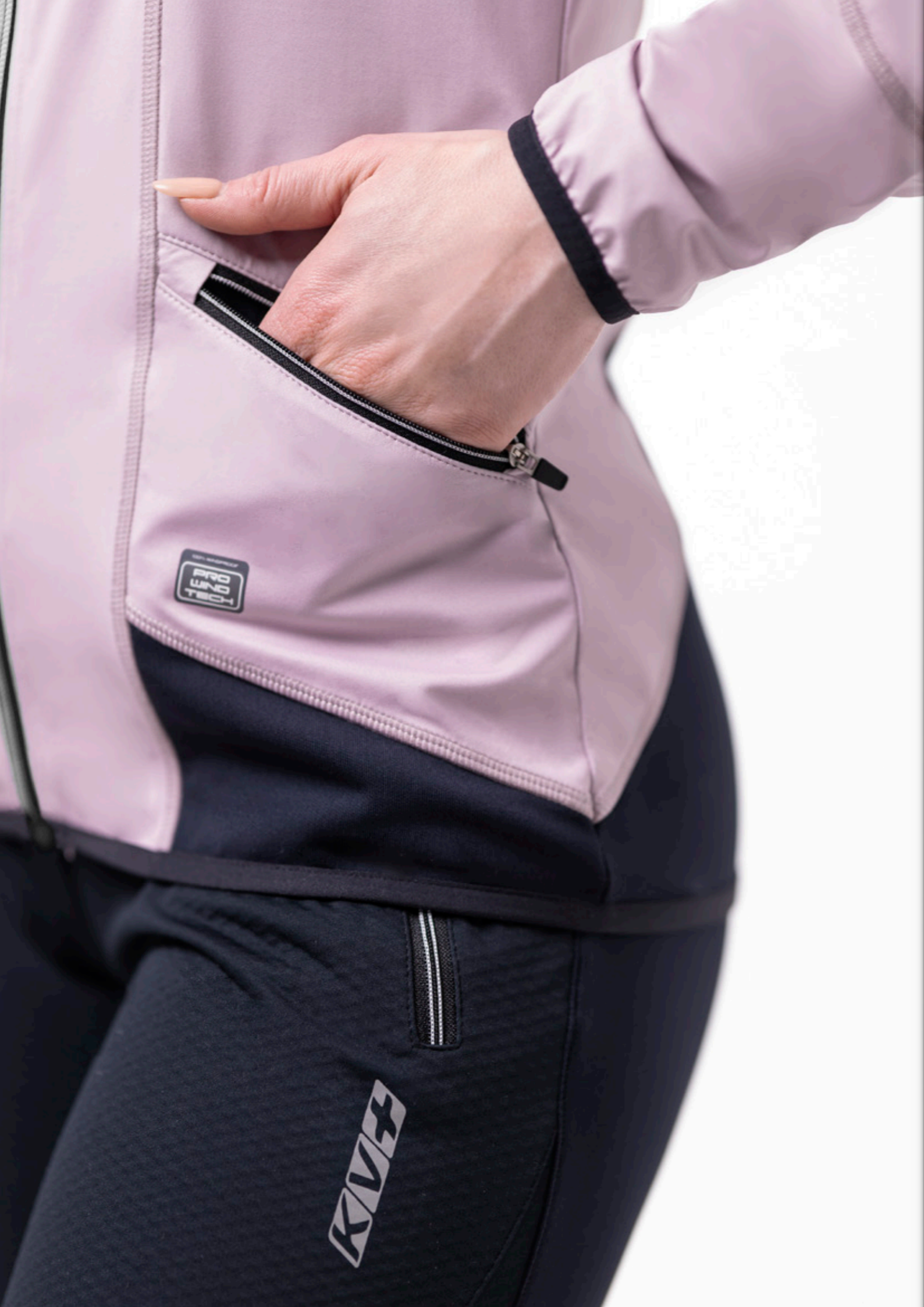

KARINA JACKET WOMAN



Wind Protection Fabric:
88% Polyester, 12% Spandex
Size: XS, S, M, L, XL

25V120.121
Lilac / Black



25V120.2
Blue



25V120.7
Green



25V120.4
Navy

KARINA PANTS WOMAN

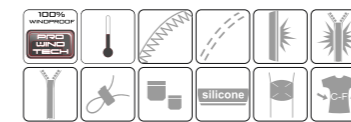

Wind Protection Fabric:
88% Polyester, 12% Spandex
Size: XS, S, M, L, XL

25V121.1
Black



25V121.4
Navy



POLARIS SKIRT WOMAN

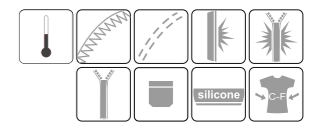

Fabric: 88% Polyester, 12% Spandex
Size: XS, S, M, L, XL

25V137.4
Navy





LAPLAND XC TRAINING JACKET UNISEX



Pro-wind-tech fabric: 50% Polyester,
35% Nylon, 15% Spandex
Size: XS, S, M, L, XL, XXL, 3XL

25V116.1

Black



25V116.12

Black / Blue

25V116.4

Navy / Black



25V116.7

Green / Black

LAPLAND XC PANTS UNISEX



Pro-wind-tech fabric:
50% Polyester, 35% Nylon, 15% Spandex
Size: XS, S, M, L, XL, XXL, 3XL

25V117.1

Black



LAPLAND XC VEST UNISEX

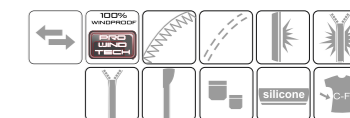

Pro-wind-tech fabric:
50% Polyester, 35% Nylon, 15% Spandex
Size: XS, S, M, L, XL, XXL, 3XL

25V142.1

Black



25V142.4

Navy

LAPLAND WARM JACKET
UNISEX

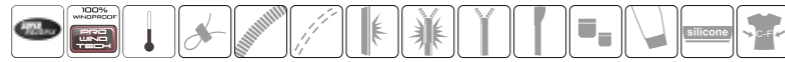

Pro-wind-tech fabric:
95% Polyester, 5% Spandex
WITH FLEECE LINING
Size: XS, S, M, L, XL, XXL, 3XL

25V150.1

Black



25V150.12

Black / Blue



25V150.4

Navy / Black



25V150.7

Green / Black

LAPLAND WARM PANTS
UNISEX



Pro-wind-tech fabric:
95% Polyester, 5% Spandex
WITH FLEECE LINING
Size: XS, S, M, L, XL, XXL, 3XL

25V151.1

Black



DAKOTA JACKET WATER-PROOF

Fabric: 50% Polyester, 50% Nylon
Colour: Black
Man Size: S, M, L, XL, XXL, 3XL
Woman Size: XS, S, M, L, XL

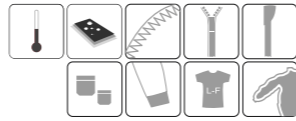

24V130.1

MAN - Black



24V131.1

WOMAN - Black



DAKOTA PANTS

Fabric: 50% Polyester, 50% Nylon
Colour: Black
Man Size: S, M, L, XL, XXL, 3XL
Woman Size: XS, S, M, L, XL

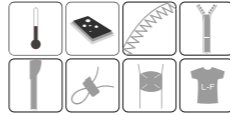

24V132.1

MAN - Black



24V133.1

WOMAN - Black



SEEFELD JACKET MAN

Fabric: 100% Nylon
Size: S, M, L, XL, XXL, 3XL

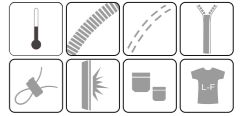

24V128.1

Black



24V128.4

Navy



LEVI JACKET WOMAN

Fabric: 100% Nylon
Size: XS, S, M, L, XL

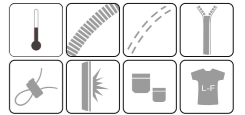

24V129.14

Old Rose



24V129.4

Navy



ARTICO JACKET

Fabric: Fabric: 50% Nylon, 42% Polyester, 8% Elastan
Man size: S, M, L, XL, XXL, 3XL
Woman size: XS, S, M, L, XL

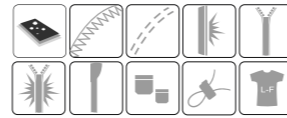

24V106.1

Black- MAN



24V119.1

Black - WOMAN



ARTICO VEST

WITH REMOVABLE SLEEVES
Fabric: 50% Nylon, 45% Polyester, 5% Elastan
Man size: S, M, L, XL, XXL, 3XL
Woman size: XS, S, M, L, XL

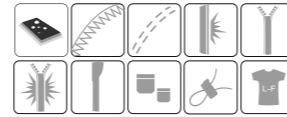

22V109.1

Black - MAN



22V134.1

Black - WOMAN



ECO BOMBER

Fabric: 88% Polyester, 12% Spandex
Man Size: S, M, L, XL, XXL, 3XL
Woman Size: XS, S, M, L, XL



25V140.4

MAN - Navy



25V141.4

WOMAN - Navy





IRELAND JACKET
WATER-PROOF
UNISEX

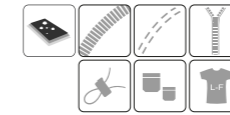

Fabric: 92% Polyester, 8% Spandex
Size: XS, S, M, L, XL, XXL, 3XL

21S25.1

Black



24S25.7

Green

IRELAND PANTS
WATER-PROOF
UNISEX

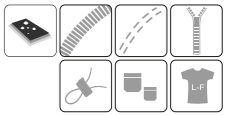

Fabric: 91% Polyester, 9% Spandex
Size: XS, S, M, L, XL, XXL, 3XL

20S26.1

Black



EXPERT PRO PANTS

Fabric: 100% Polyester
Man size: S, M, L, XL, XXL, 3XL
Woman size: XS, S, M, L, XL



24V135.1

MAN - Black

24V136.1

WOMAN - Black



FOCA JERSEY MAN

Fabric: 86% Polyester, 14% Elastane
Size: S, M, L, XL, XXL, 3XL

23V122.1

Dark Grey / Black



23V122.2

Dark Grey / Blue

FOCA JERSEY WOMAN

Fabric: 86% Polyester, 14% Elastane
Size: XS, S, M, L, XL

23V125.1

Dark Grey / Black



23V125.12

Dark Grey / Pink

FOCA JOGGER MAN

Fabric: 86% Polyester, 14% Elastane
Size: S, M, L, XL, XXL, 3XL

23V126.1

Dark Grey / Melange



FOCA JOGGER WOMAN

Fabric: 86% Polyester, 14% Elastane
Size: XS, S, M, L, XL

23V127.1

Dark Grey / Melange

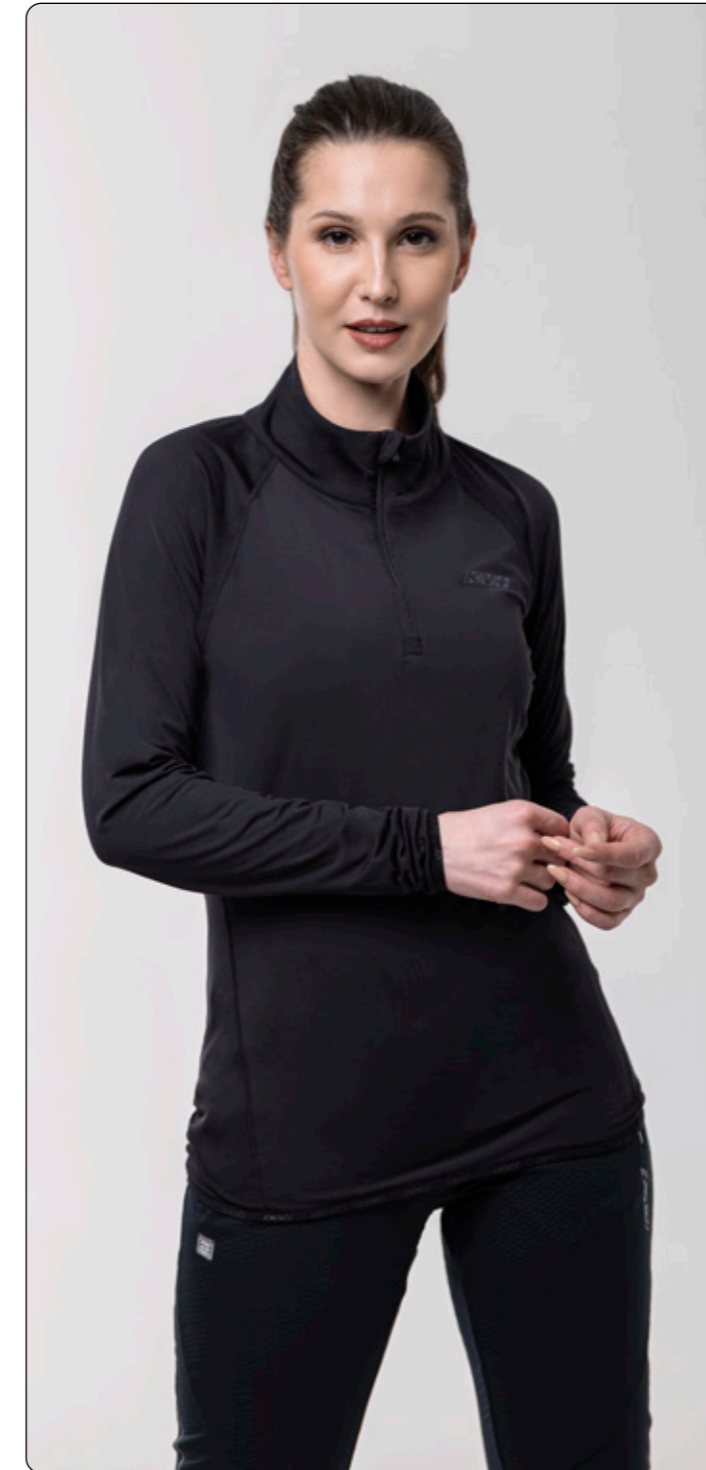

MARMOTTA MAN

Fabric: 92% Polyester, 8% Spandex
Size: S, M, L, XL, XXL, 3XL

25V138.1

Black



MARMOTTA WOMAN

Fabric: 92% Polyester, 8% Spandex
Size: XS, S, M, L, XL

25V139.1

Black





CORTINA SWEATER
MAN

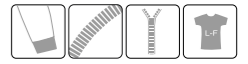

25U160.4
Navy / Grey

Fabric: 50% Merino Wool, 50% Acrylic
Size: S, M, L, XL, XXL, 3XL



25U160.43
Navy / Red / White



25U160.9
Grey / White

CORTINA SWEATER
WOMAN

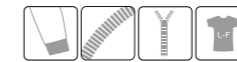

25U161.12
Lilac / White

Fabric: 50% Merino Wool, 50% Acrylic
Size: XS, S, M, L, XL



25U161.92
Grey / Turquoise



CROSS XC JACKET KID UNISEX

Fabric: 87% Polyester,
10% Polyurethane, 3% Spandex
Size: J130, J140, J150

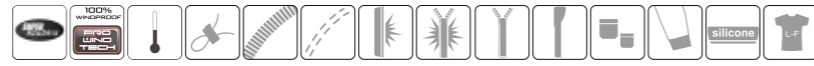

23V110.2J

Blue



23V110.3J

Red

CROSS XC VEST KID UNISEX

Fabric: 87% Polyester,
10% Polyurethane, 3% Spandex
Size: J130, J140, J150

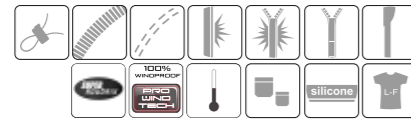

21V113.1J

Black



CROSS XC PANTS KID UNISEX

Fabric: 87% Polyester,
10% Polyurethane, 3% Spandex
Size: J130, J140, J150

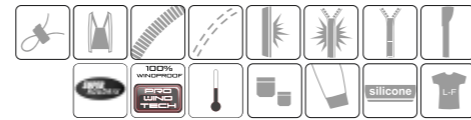

21V111.1J

Black
With Removable Braces



TORNADO TWO PIECES SUIT KID UNISEX

Fabric: 82% Polyester, 18% Spandex
Size: J130, J140, J150

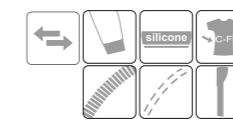

23V118.20J

Blue / White



SEEFELD JACKET KID UNISEX

Fabric: 100% Nylon
Size: J130, J140, J150

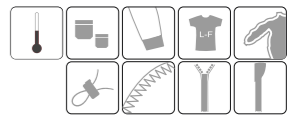

24V128.J

Black



TENERO UNDERWEAR KID UNISEX

Fabric: 88% Polyester, 12% Spandex
Size: J130, J140, J150

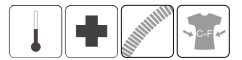

21U133.1J

Dark Grey



21U134.1J

Dark Grey



UNDERWEAR



WINTER 2024/25



KVA WINTER 2024/25 CATALOGUE

UNDERWEAR

81

COCCOLA SHIRT

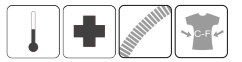

Fabric: 80% Tencel, 20% Wool
Man Size: S, M-L, XL-XXL
Woman Size: XS-S, M-L

25U108.1

MAN - Black

25U110.0

WOMAN - White



COCCOLA PANTS



Fabric: 80% Tencel, 20% Wool
Man Size: S, M-L, XL-XXL
Woman Size: XS-S, M-L

25U109.1

MAN - Black

25U111.0

WOMAN - White



FIOCCO SHIRT

Fabric: 88% Polyester, 12% Elastan
Man Size: S, M-L, XL-XXL
Woman Size: XS-S, M-L



24U100.1

MAN - Blue



24U102.1

WOMAN - Old White



FIOCCO PANTS

Fabric: 88% Polyester, 12% Elastan
Man Size: S, M-L, XL-XXL
Woman Size: XS-S, M-L



24U101.1

MAN - Blue



24U103.1

WOMAN - Dark Grey



TENERO SHIRT

Fabric: 88% Polyester, 12% Elastan
Man Size: S, M-L, XL-XXL **Woman Size:** XS-S, M-L



21U133.1

MAN - Dark Grey



21U131.1

WOMAN - Dark Grey



TENERO PANTS

Fabric: 88% Polyester, 12% Elastan
Man Size: S, M-L, XL-XXL **Woman Size:** XS-S, M-L



21U134.1

MAN - Dark Grey



21U132.1

WOMAN - Dark Grey



TENERO BOXER

Pro-wind-tech fabric: 88% Polyester, 12% Elastan
Man Size: M-L, XL-XXL **Woman Size:** XS-S, M-L



21U107.1

MAN - Dark Grey



21U106.1

WOMAN - Dark Grey



JULIER SHIRT

Pro-wind-tech fabric: 88% Polyester, 12% Elastan
Man Size: S, M, L, XL, XXL, 3XL
Woman Size: XS, S, M, L, XL



21U121.1

MAN - Dark Grey / Black



21U123.1

WOMAN - Dark Grey / Black



JULIER PANTS

Pro-wind-tech fabric:
 88% Polyester, 12% Elastan
Man Size: S, M, L, XL, XXL, 3XL
Woman Size: XS, S, M, L, XL



21U122.1

MAN - Dark Grey / Black



21U124.1

WOMAN - Dark Grey / Black



NORDIC STEP SOCKS

Achilles Tendon Pad / Instep Pad /
 Footstep Protector
Fabric: 40% Cotton, 40% Polyester, 15%
 Lycra elastic, 5% Nylon
Colour: Dark Grey / Blue
Size: 35-38, 39-42, 43-46



6U21.1

NORDIC STEP WOOL

Achilles Tendon Pad / Instep Pad /
 Footstep Protector
Fabric: 50% Merino wool, 50%
 polyester
Colour: Grey / Blue
Size: 36-39, 40-43, 44-47



25U21.92

POLAR POWER

Achilles Tendon Pad
 / Instep Pad
 / Footstep Protector
Fabric: 100% polyester
Colour: Black
Size: S, M, L, XL



25U24.1

Provided with battery



NORDIC STEP SOCKS

Achilles Tendon Pad / Instep Pad /
 Footstep Protector
Fabric: 100% polyester
Colour: Grey / Black
Size: 36-39, 40-43, 44-47



25U20.91

1 pair



25U20B.91

3 pair

Model No.	KNK-2022
Dimension	82.0mm*48.5mm*16.0mm(L*W*H)
Cell Type	Li-ion polymer battery
Cell Model	114065PL 4000mAh
Typical Capacity	3.7 V/4000mAh at 0.2C
Minimum Capacity	3.7 V/ 3950mAh at 0.2C
Cycle life	300 (times) 0.2C 80%
Cell Certification	UL/CB/CQC GB31241
Charging Parameters	input DC 4.75V-5.25V, the max charge current is 2.0A Max.
Working temperature range	-20 ~ 45°C
Storage temperature	-10 ~ 50°C within 1 months -10 ~ 40°C within 6 month
Humidity range	Operation humidity range: Less than 75% RH Storage
Weight	82,5 g

Display the electric quantity:		
○○○	No power	No power
○ ○ ○	<5%	The first LED flashing, Battery low voltage alarm
● ○ ○	6%—33%	One LED on
● ● ○	34%—66%	Two LED on
● ● ●	67%—100%	Three LED on

Warning and cautions:

To prevent the possibility of the power bank from leaking, heating, fire, please observe the following precautions:
 The soft aluminum packing foil is prone to be damaged by sharp edge parts such as MI-tabs and needs, do not wreck battery with any sharp edge parts. Do not immerse the power bank in fresh water or seawater.
 Do not use and leave the power bank near a heat source such as fire and heater.
 Do not reverse use the position and negative terminals.
 Do not charge the power bank with unknown electrical outlet directly or other uncertain charging station.
 Do not transport and store the power bank together with metal objects such as necklaces, hairpins.
 Do not strike, throw or trample the power bank.
 Do not pierce the battery with a nail or other sharp object.
 Do not drop, hit or bend the power bank.
 Battery replacement shall be conducted only by either battery supplier or device supplier. Unauthorized replacement by user is prohibited.
 If the power bank diffuses odors, generates heat, becomes discolored or deformed, or in any way appear abnormal during use, recharging or storage, remove it from the charging station and stop using immediately.
 Do not use or leave the power bank under high temperature conditions (for example, strong direct sunlight or a vehicle in extremely hot conditions). Otherwise, it may cause overheat, fire, performance degeneration or decreased cycle life.
 Do not disassemble the power bank casing to avoid possible damage to the battery core and other hazards.
 Do not disassemble, squeeze, puncture, or short-circuit the power bank or put it into water, fire or exposed to temperatures above 60 ° C (140 ° F)

GLOVES



WINTER 2024/25



COLD PRO

Size: XXS, XS, S, M, L, XL, XXL

Fabric: 50% Polyester, 35% Polyurethane, 15% Nylon

- Windproof with high breathable Pro Wind Tech membrane

- HEAT ●●●●○
- BREATH ●●○○○
- RACING ●●●●○
- WATER-PROOF ●●●○○
- WIND-PROOF ●●●●●

24G05.1

Black



24G05.S

Black / Red



24G05.N

Black / Red



25G05.121

Black / Turquoise



Size: XXS, XS, S, M, L

Fabric: 50% Polyester, 35% Polyurethane, 15% Nylon

- Windproof with high breathable Pro Wind Tech membrane

25G05.114

Black / Lilac



FOCUS

Size: XXS, XS, S, M, L, XL, XXL
Fabric: 45% Nylon, 25% Polyester, 25% Polyurethane, 5% Elastane
 • Windproof with high breathable Pro Wind Tech membrane

HEAT ●●●○○
BREATH ●●●●○
RACING ●●●●●
WATER-PROOF ●●○○○
WIND-PROOF ●●●●○

25G07.1
Black



25G07.2
Black / Blue



FOCUS KANGAROO

Size: XXS, XS, S, M, L, XL, XXL
Fabric: 100% Synthetic / 100% Kangaroo leather
 • Windproof with high breathable Pro Wind Tech membrane

HEAT ●●●○○
BREATH ●●●○○
RACING ●●●●●
WATER-PROOF ●●○○○
WIND-PROOF ●●●●○

21G07.10
Black / Kangaroo



RACE

Size: XXS, XS, S, M, L, XL, XXL
Fabric: 45% Nylon, 25% Polyester, 25% Polyurethane, 5% Elastane
 • Windproof with high breathable Pro Wind Tech membrane
 • Bossed fabric on the palm

HEAT ●●●○○
BREATH ●●●●○
RACING ●●●●●
WATER-PROOF ●●○○○
WIND-PROOF ●●●●○

24G08.2
Royal / Black



24G08.1
Black



ELITE XC

Size: XXS, XS, S, M, L, XL, XXL
Fabric: 45% Nylon, 25% Polyester, 25% Polyurethane, 5% Elastane

HEAT ●●●○○
BREATH ●●●●○
RACING ●●●●●
WATER-PROOF ●●○○○
WIND-PROOF ●●●○○

25G04.1
Black / Royal



GLACIER

Size: XXS, XS, S, M, L, XL, XXL
Fabric: 50% Polyester, 35% Polyurethane, 15% Nylon
 • Made of windproof and Water-proof materials

HEAT ●●●●●
BREATH ●●●●○
RACING ●●○○○
WATERPROOF ●●●●○
WINDPROOF ●●●●●

22G06.1
Black



BLIZZARD

Size: XXS, XS, S, M, L, XL, XXL
Fabric: 50% Polyester, 35% Polyurethane, 15% Nylon
 • Made of windproof and Water-proof materials

HEAT ●●●●●
BREATH ●●●●○
RACING ●●○○○
WATERPROOF ●●●●○
WINDPROOF ●●●●●

22G11.1
Black



ALASKA XC

Size: XXS, XS, S, M, L, XL, XXL
Fabric: 45% Sheep skin, 45% Polyester, 10% Nylon
 • Made of windproof and Water-proof materials

HEAT ●●●●●
BREATH ●●●●○
RACING ●●○○○
WATERPROOF ●●●●○
WINDPROOF ●●●●●

24G09.1
Black



ALASKA POWER

Size: XXS, XS, S, M, L, XL, XXL
Fabric: 45% Sheep skin, 45% Polyester, 10% Nylon
 • Made of windproof and Water-proof materials
 • With Battery

HEAT ●●●●●
BREATH ●●●●○
RACING ●●○○○
WATERPROOF ●●●●○
WINDPROOF ●●●●●

25G14.1
Black



Provided with battery



LAPLAND XC

Size: XXS, XS, S, M, L, XL, XXL
Size Junior: JM, JL
Fabric: 50% Polyester, 40% Synthetic leather, 10% Nylon
 • Made with high breathable Pro Wind Tech membrane

HEAT ●●●●○
BREATH ●●●●○
RACING ●●●○○
WATERPROOF ●●●○○
WINDPROOF ●●●●●

25G10.1
Black



25G10.1J
JUNIOR - Black



COVER

Size: S, M-L, XL
Fabric: 50% Polyester, 30% Polyurethane, 20% Nylon
 • Extra protection against wind and cold

8G12.1
Black



FINGER COVER FOR TOUCH SCREEN

Size: S, L
 To be worn over the glove

9G03.1
Black



HEADWEAR

KVVE

WINTER 2024/25



KVVE WINTER 2024/25 CATALOGUE

HEADWEAR

93

ST.MORITZ

22A12

Fabric: 80% Lambs Wool, 20% Nylon, Inside fleece band



VENTO

23A08

Fabric: Fabric: 80% Lambs Wool, 20% Nylon, Inside fleece band



TIROL

25A06

Fabric: 100% Acrylic, Inside fleece band



GOMS

22A11

Fabric: 80% Lambs Wool, 20% Nylon with inside fleece band



FIOCCO

25A13

Fabric: 50% Wool, 50% Acrylic, Inside fleece band



PATRIOT

22A01

Fabric: 50% Wool, 50% Acrylic, Inside fleece band



RACING

8A19

Fabric: 100% Polyester with reflex tape



BERGEN

8A22

Fabric: 100% Polyester



PREMIUM

22A02

Fabric: 92% Polyester, 8% Spandex

22A02.S

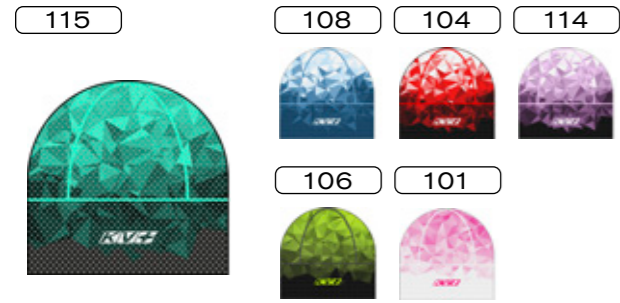

TORNADO

22A16

Fabric: 92% Polyester, 8% Spandex

22A16.S

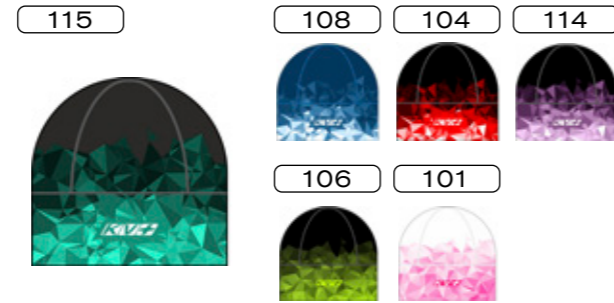

TORNADO HEADBAND

Fabric: 92% Polyester, 8% Spandex

22A03

22A03.S



BANDANA

Fabric: 100% Polyester



KV+ CAP

24U152

Embroidered logo

24U153

Flat visor

110

106

107

110



KVplus SA
6715 Dongio
SWITZERLAND
tel: +41(0) 918722616
fax: +41(0) 918722008
mail: info@kv2.ch
WWW.KVPLUS.COM



WWW.KVPLUS.COM